

Internal Framing
Of Cupola Columns

Looking West at East elevation

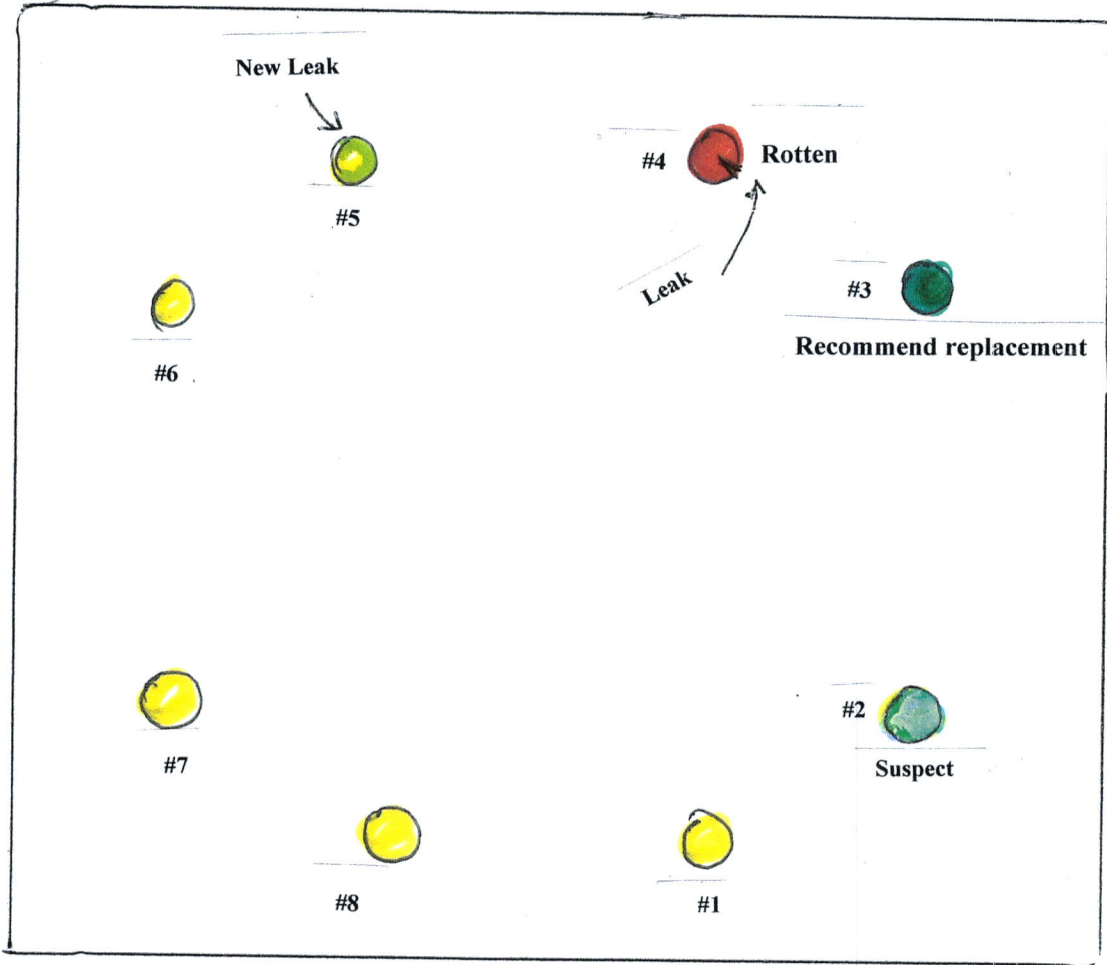





W

E

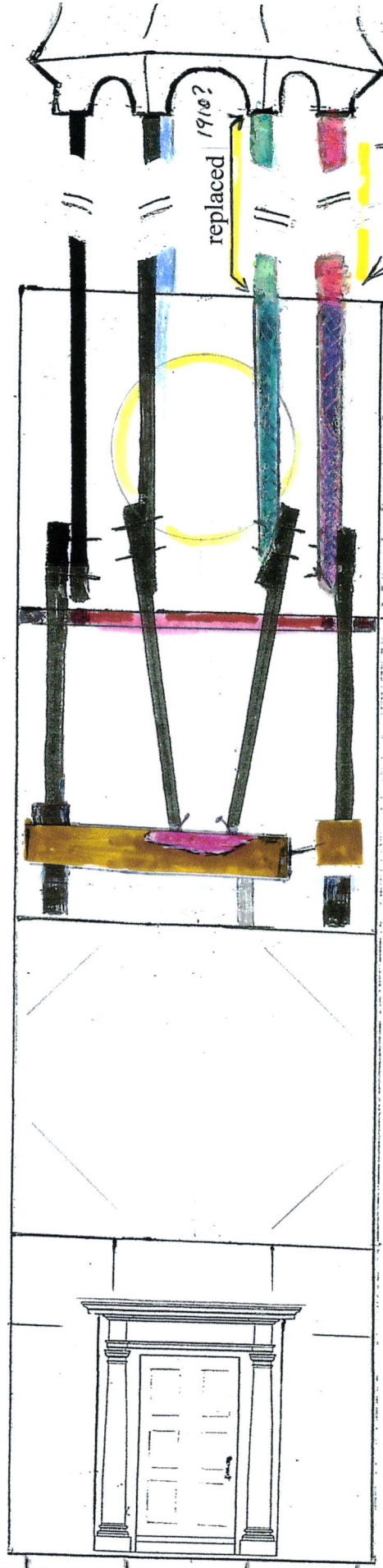
S

3.



-  Recommend replacement
-  Rotten
Needs replacement
-  Suspect
-  Needs replacement

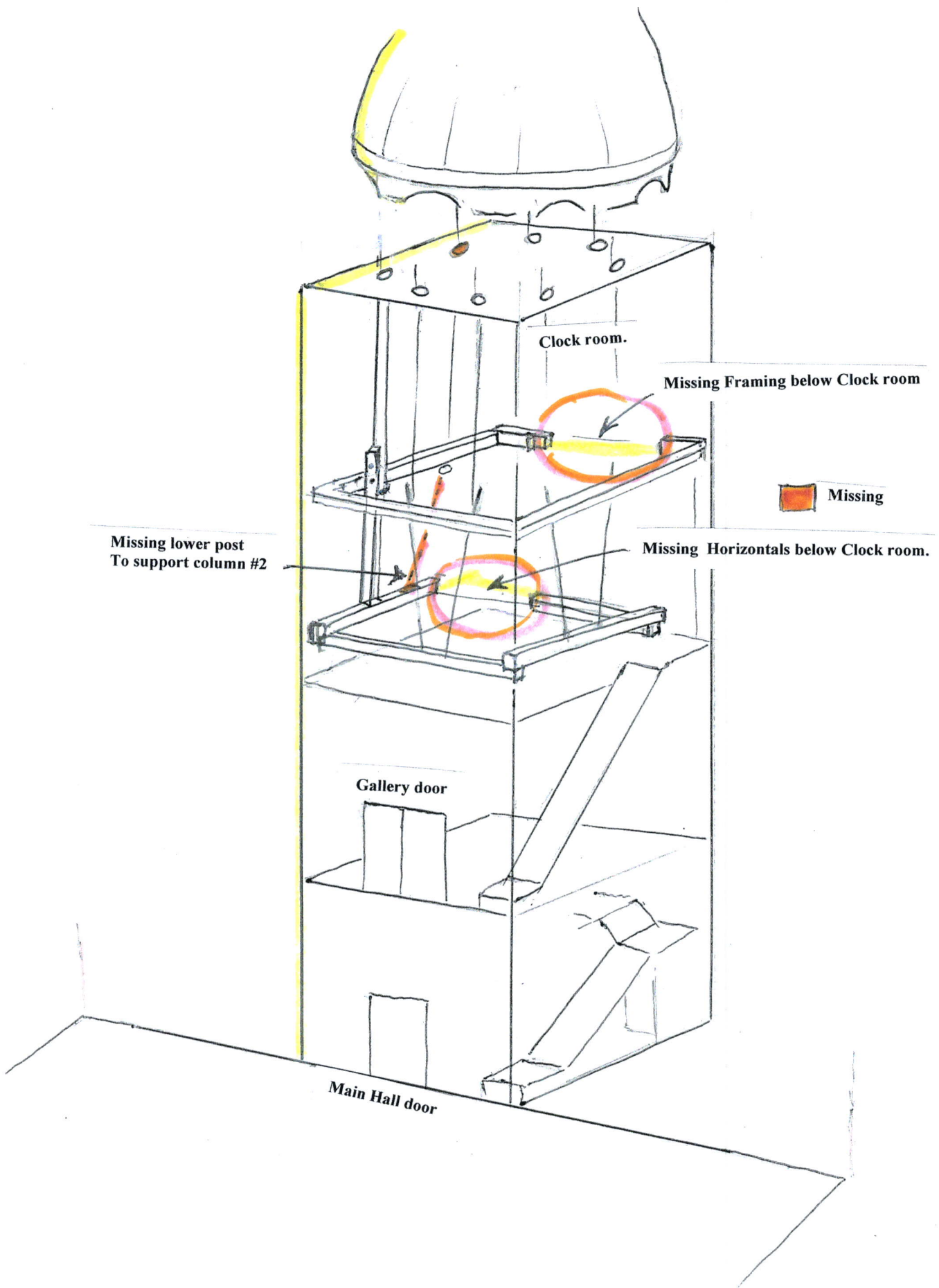

Clock room.

5.

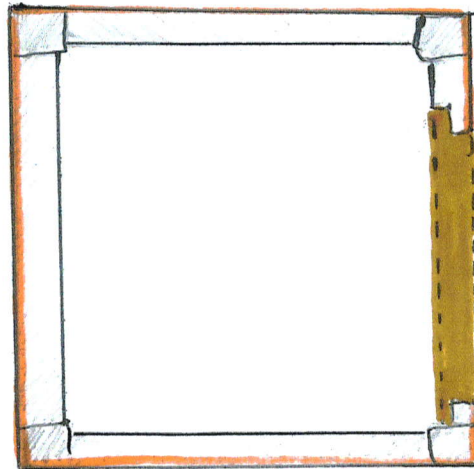
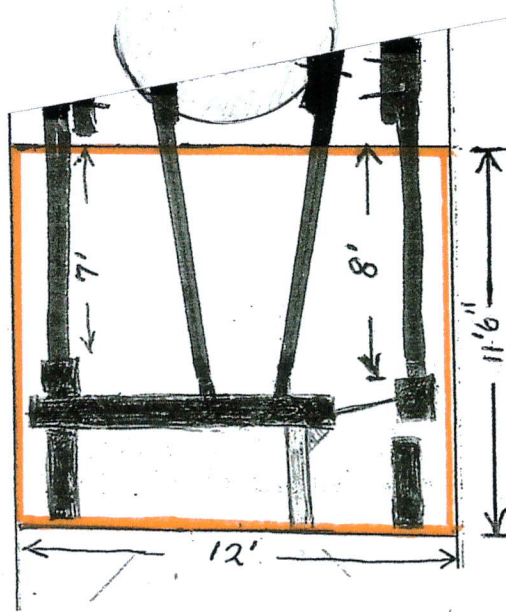

East

Missing Framing below Clock room



Missing horizontals

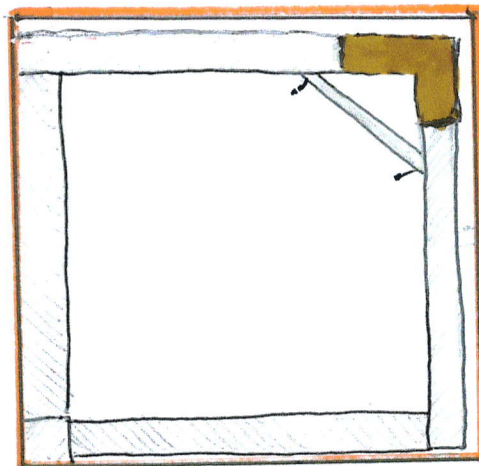

East

THOMAS GEOGHEGAN



Repair beneath East clock room floor needing replacement. Provides little or no actual support to the structure.



Missing 6x12" supports to lower cupola columns due to 1893 clock installation.

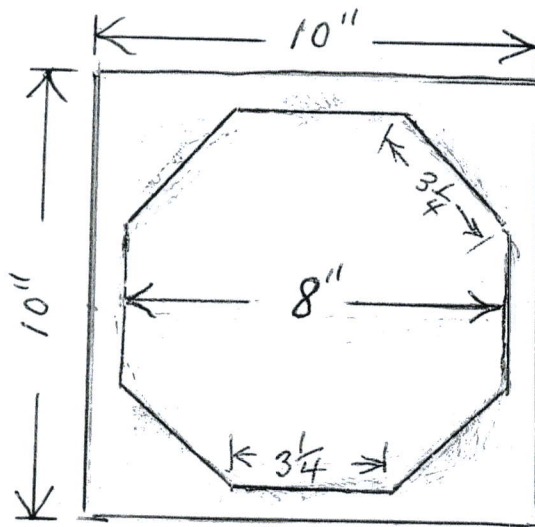
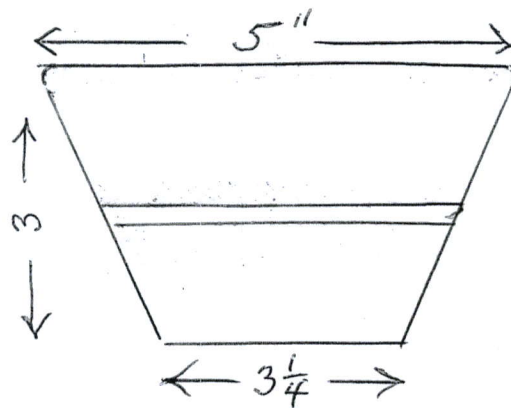
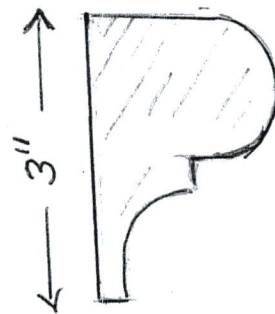
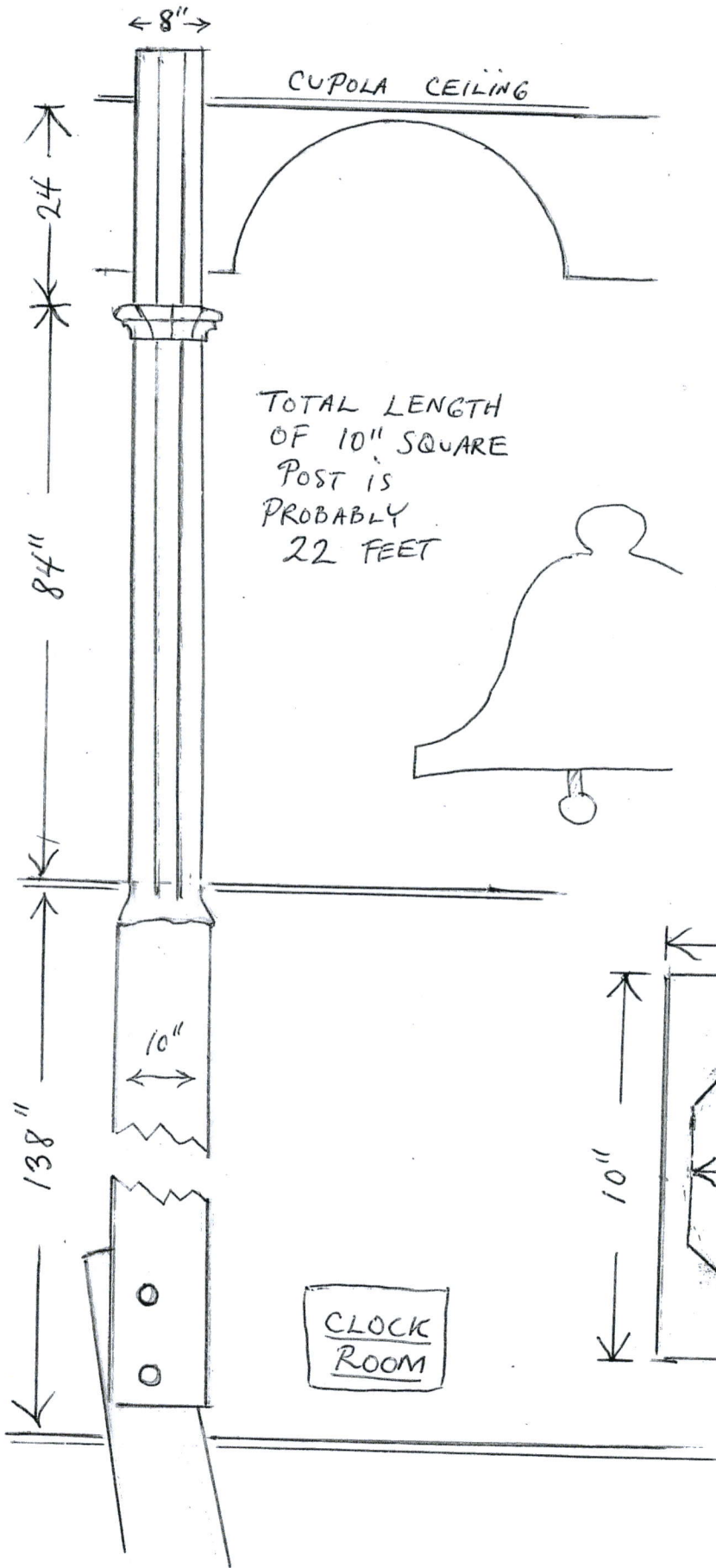

OCTAGONAL POST CUT FROM 10" SQUARE POST.